

Alera 1

USER MANUAL

- 40 cm - 105 cm
- 0 - 4 years
- ≤21.5 kg
- UN ECE R129/04



GB

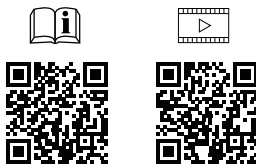

Made in Germany

A5115041-1.25/10

1 PRODUCT OVERVIEW

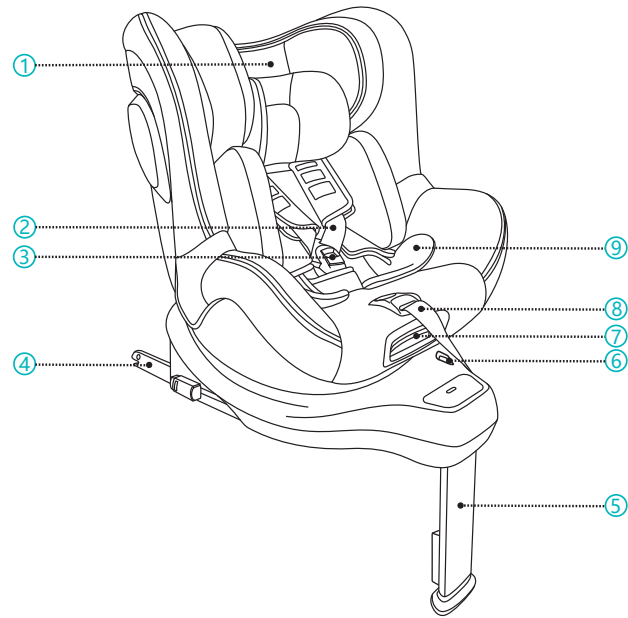

- | | |
|---------------------------|--|
| 1. Headrest | 6. Age Limiter |
| 2. 5-point Harness | 7. Rotation Release/Recline Adjustment |
| 3. 5-point Harness Buckle | Handle |
| 4. ISOFIX Connector | 8. 5-Point Harness Adjuster |
| 5. Support Leg | 9. Newborn Insert |

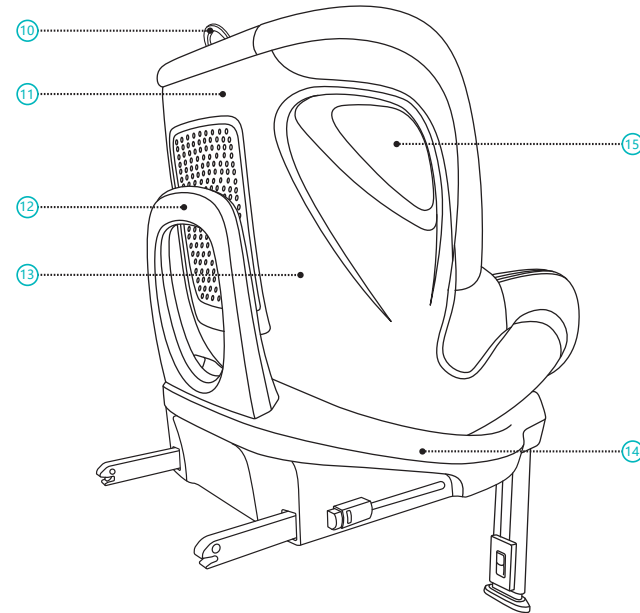

- | | |
|------------------------------|---|
| 10. Headrest Adjustment Ring | 13. Shell |
| 11. Backrest | 14. Base |
| 12. Rebound Bar | 15. ISIP(Integrated Side Impact Protection) |

2 INSTRUCTION

Thank you for choosing AVOVA Alera 1 to ensure your child's safe journey. The seat has been designed, tested and certified according to the UNECE R129, the Enhanced Child Restraint Systems. The orange approval label with the certification mark and approval number is located on the back of the base. The seat may only be used in countries that recognize the UN ECE regulations. The child seat is designed for a child with statures of 40 cm-105 cm, approximately from 0 - 4 years old. It is important that you read this user manual BEFORE installing your child seat. Incorrect installation and/or misuse of the seat could endanger your child. This user manual should be kept in the pocket behind headrest cover so users can refer to it anytime. These instructions for use are an integral part of the product and contribute to its safe use.

Important note:
Our UN-ECE R129-approved seats cannot be used in countries that have their own national certification standards and do not accept UN ECE regulations, such as: United States/Canada/Australia etc.

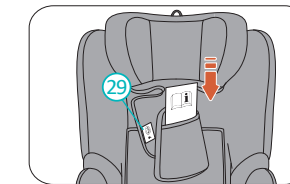

After use, please place the user manual into the storage pocket located at the backside of the headrest cover (the label 29 on the cover indicates the user manual storage position).

The following symbols are used in this user manual:

⚠ DANGER DANGER indicates a hazardous situation which, if not avoided, will result in death or serious injury.

⚠ WARNING WARNING indicates a hazardous situation which, if not avoided, could result in death or serious injury.

⚠ CAUTION CAUTION indicates a hazardous situation which, if not avoided, could result in minor or moderate injury.

GENERAL SAFETY INFORMATION

⚠ DANGER AVOVA Alera 1 is approved for statures of 40 cm–105 cm, in the rearward-facing direction, and 76 cm-105 cm, in the forward-facing direction.

⚠ DANGER It is mandatory to use the child seat in rearward-facing direction when your child is less than 15 month. Once your child is older than 15 month and reaches 76 cm, you can use the child seat in either the rearward-facing direction or the forward-facing direction.

⚠ DANGER AVOVA Alera 1 can only be used in vehicle seats with ISOFIX Anchoring Points. Please check Vehicle Fitting List for information.

⚠ DANGER The child seat must not be used rearward-facing on a vehicle seat with active airbag. An active airbag will cause serious injury to a child in rearward-facing child seat. The child seat must be installed on a vehicle seat without active airbag or with airbag deactivated.



⚠ DANGER Always use the 5-point harness to secure your child.

⚠ DANGER When the child is taller than 105 cm or the child's shoulders exceed the highest position of the shoulder harness belt, the child must change to a seat which is suitable for taller children.

⚠ DANGER The Newborn Insert must be used until your child exceeds a height of 60 cm.

⚠ DANGER AVOVA Alera 1 has been approved for statures between 40 cm and 105 cm using ISOFIX Connectors and Support Leg 5 in vehicles.

⚠ DANGER Always use the Support Leg to install the child seat along with ISOFIX Connectors. The Support Leg shall be in contact with the vehicle floor, with the Support Leg Indicator showing green.

⚠ DANGER AVOVA Alera 1 is compatible with universal seating positions in vehicles. For suitable positions in your vehicle, please read your vehicle handbook.

⚠ DANGER Never leave your child unattended in the child seat.

⚠ DANGER Please dispose of your seat in the event of any vehicle and/or violent collision as the child seat may be damaged but the damage may not be immediately visible.

⚠ DANGER Do not use lubricants on or modify in any way your Alera 1 as this could seriously affect its ability to protect your child.

⚠ DANGER Use on the rear seat: Move the front seat forward far enough that the child's feet cannot reach the backrest of the front seat as that is safer.

⚠ DANGER Make sure all passengers are informed about how to release your child in the case of an emergency.

⚠ DANGER Make sure luggage or other objects are properly secured. Unsecured luggage may cause severe injuries to children and adults in case of accidents.

⚠ DANGER If in doubt, consult either the child seat manufacturer or the retailer.

⚠ DANGER AVOVA advises that child seats should not be bought or sold second-hand.

⚠ WARNING The child seat must always be secured when it is in the vehicle by using ISOFIX Anchoring Points, even if no child is being transported.

⚠ WARNING Please do not expose the child seat under intensive direct sunlight. Under intensive direct sunlight, the child seat or some of the child seat parts can get very hot which can cause harm to the child.

⚠ WARNING The rigid items and plastic parts of a Alera 1 shall be so located and installed that they are not liable, during everyday use of the vehicle, to become trapped by a movable seat or in a door of the vehicle.

⚠ WARNING The child seat needs to be checked regularly to ensure all the parts are functioning correctly and free from any damages.

⚠ WARNING DO NOT use at home. It's not designed for home use and can only be used in a vehicle.

⚠ CAUTION Do not use any aggressive cleaning products, which may harm the construction material of the child seat.

⚠ CAUTION The vehicle seats may show signs of wear and tear when using child seat. In order to avoid that, car seat protectors may be used.

3 INSTALLATION

GETTING READY

⚠ DANGER Please ensure the vehicle seat that has the child seat installed is in upright position if the vehicle seat is reclinable.

The seat must be installed by use of ISOFIX Connectors 4 connected to the ISOFIX Anchoring Points 16 and attaching the Support Leg 5 to the vehicle floor. It is compatible with universal seating positions in vehicles. Please read your vehicle handbook.

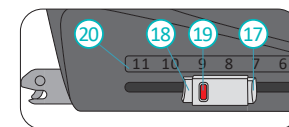

- ISOFIX Release Button A 17
- ISOFIX Release Button B 18
- ISOFIX Indicator 19
- ISOFIX Position Illustrator 20

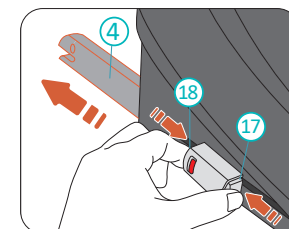

1. To release the ISOFIX Connector, press and hold both ISOFIX Release Button A 17 and ISOFIX Release Button B 18, and then push out the ISOFIX Connector 4 fully out from the Seat Base. Do this on both sides.

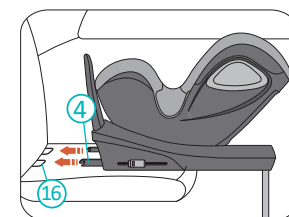

2. Put the child seat on the vehicle seat and aim both ISOFIX Connectors 4 to the ISOFIX Anchoring Points 16 in the vehicle seat. For some vehicles, the ISOFIX anchoring point covers may need to be removed prior to the installation (check vehicle manual)

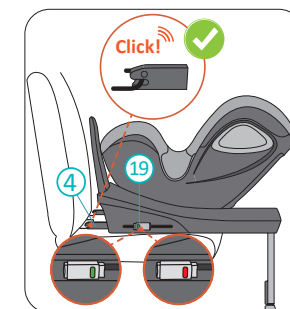

3. Push one ISOFIX Connector 4 to engage it with the ISOFIX Anchoring Point with a click sound. Repeat the action on the other side to engage both ISOFIX Connectors.

⚠ DANGER Check both ISOFIX Indicators 19, and if they both show green the ISOFIX Connectors are locked successfully.

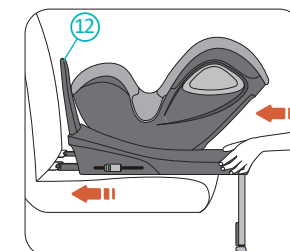

4. Push the child seat firmly towards the vehicle seat backrest as far back as possible until the Rebound Bar 12 rests firmly against the vehicle seat backrest.

⚠ DANGER Please check that the child seat is connected securely by trying to pull it out from both sides.

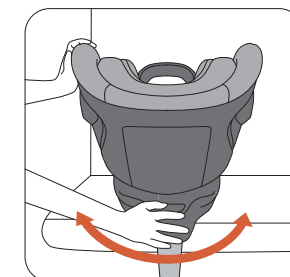

5. Move the car seat from side to side and increase the tension of the ISOFIX connection against the vehicle backrest.

⚠ DANGER The extruding position of the ISOFIX Connector is shown by numbers on ISOFIX Position Illustrator 20 aligned with the ISOFIX Indicator. The ISOFIX Indicators on both left and right sides of the child seat must be aligning to the same numbers on ISOFIX Position Illustrators.

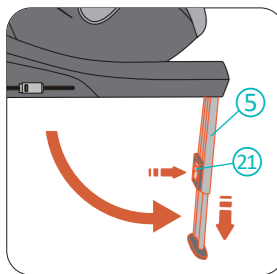

6. The Support Leg (5) shall be deployed to the most outward position (almost perpendicular to the Base) before installation. Press the Support Leg Release Button (21) to lengthen the Support Leg till it touches the vehicle floor and the Support Leg Indicator shows green. Ensure the Base is on the vehicle seat, not away from it. Then while holding the Support Leg Release Button, raise the upper part of Support Leg upward so it is locked in the next and longer position to provide optimum safety.

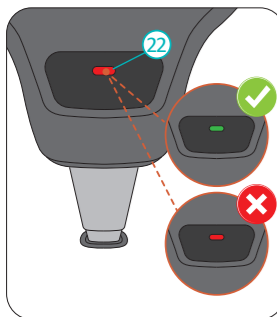

⚠ DANGER The Support Leg shall be firmly engaged to the vehicle floor, until the Support Leg Indicator (22) shows green.

⚠ DANGER The Support Leg must be firmly engaged to the vehicle floor, not free from the vehicle floor or touching other objects. The length of the Support Leg can slightly raise the child seat upwards and being softly in contact with the vehicle seat.

4 CHILD SEAT ROTATION

AVOVA Alera 1 has a Seat Shell that can be rotated 360 degrees on the child seat Base. When your child is younger than 15 months and less than 76 cm in stature, always secure your child in the rearward-facing direction. When your child is between 76 cm and 105 cm in stature, secure your child in either the rearward-facing direction or forward-facing direction.

⚠ DANGER The child seat can be rotated to face sideways (towards the vehicle door) for easy access only, but never transport your child in this way.

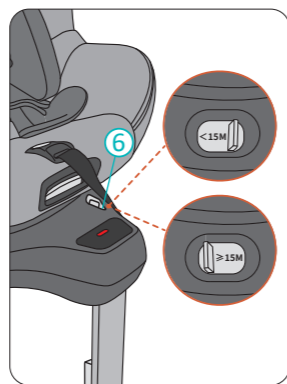

The child seat comes with the Age Limiter (6), the use of which is to prevent the misuse of the rotation system by limiting the forward-facing direction before the child is over 15 months old. The Age Limiter has 2 positions, for below and over 15 months of age. Please slide it according to your child's age. When your child is below 15 months, the Shell can be rotated to rearward-facing and side-facing directions only. When your child is over 15 months and more than 76 cm, all rotation directions are available.

⚠ DANGER Do not turn the child seat forward-facing before your child is at least 15 months in age and 76 cm in stature.

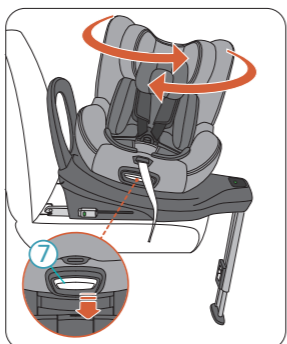

Squeeze the Rotation Release Handle (7) to release the child seat Shell from its locked position. Now you can rotate the child seat Shell. The child seat Shell has two locked positions, forward-facing and rearward-facing. When the child seat Shell is moved to a locked position, it will automatically lock with a click sound. The child seat Shell also has two side intermediate stopping positions (unlocked) so that the child can be put in or take out from the seat easily.

⚠ DANGER Before each travel, make sure the child seat Shell is locked by trying to rotate it without releasing the Rotation Release Handle (7).

⚠ DANGER Do not travel when the child seat is not locked in either the forward-facing or rearward-facing direction. Side-facing is not allowed for travel.

5 ADJUSTING THE RECLINE



AVOVA Alera 1 has three recline positions in forward-facing direction and three recline positions in rearward-facing direction. To adjust the recline position, squeeze the Recline Adjustment Handle (7) and slide the child seat Shell by pushing and pulling it back and forth against the child seat Base.

6 USE OF THE NEWBORN INSERT



Always use the Newborn Insert (9) when your child is at least 40 cm and no more than 60 cm in stature. It becomes optional from 61 cm to 75 cm. Do not use Newborn Insert after your child is over 76 cm in stature.

⚠ WARNING After securing your baby, adjust the head pad part of the Newborn Insert to align it with the baby's head.

7 POSITIONING THE CHILD ADJUST HEADREST BEFORE SECURING YOUR CHILD.

⚠ CAUTION Loosen the 5-Point Harness (2) before adjusting the Headrest (1).

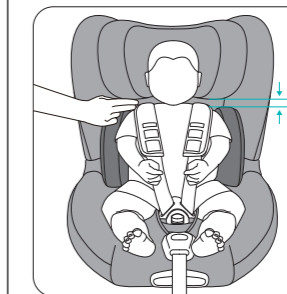

⚠ DANGER The Headrest shall be adjusted to a level that the lower edges of the headrest are just above the child's shoulders and the gap must not be greater than 2 cm in width (about 2 fingers wide).

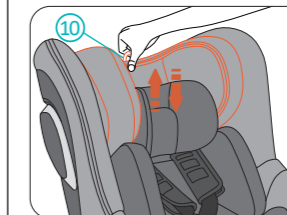

Pull and hold the Headrest Adjustment Ring (10) to release the Headrest (1). Pull the ring up to move the Headrest to higher positions. Hold the ring and push down the Headrest to move the Headrest to lower positions. When the Headrest is at the desired position, release the ring to lock the Headrest.

SECURING YOUR CHILD

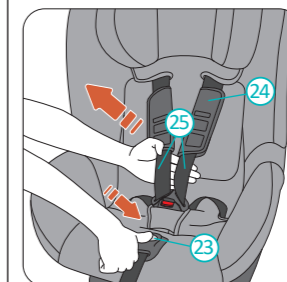

1. Hold down the Harness Adjustment Button (23) and pull shoulder harness (25) towards you as much as possible. Make sure you pull the shoulder harness from beneath the Chest Pads (24) as shown.

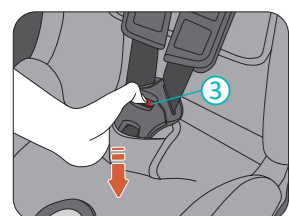

2. Press the red button on the 5-Point Harness Buckle (3) to unbuckle it.

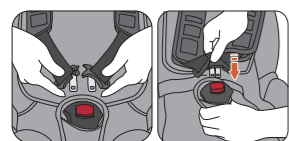

3. Seat your child in Alera 1. Route the shoulder harness directly over your child's shoulders and engage the buckle tongues together. A clear "click" sound should be heard to ensure the tongues have engaged into the buckle body properly.



4. Pull both shoulder harness (25) to tighten the lap harness (26).

⚠ DANGER Please check that the Lap harness is worn low down so that the child's pelvis is firmly engaged.

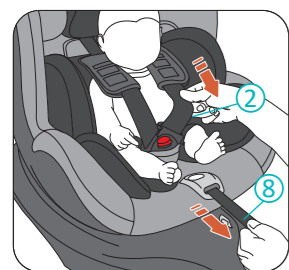

5. Pull the 5-point harness adjuster (8) until the harness (2) firmly secures your child.

⚠ DANGER Please check after tightening that none of the harness straps are twisted, and definitely no slack remains.

6. Finally pull both chest pads down fully.

REMOVING YOUR CHILD

Follow step 1 of "SECURING YOUR CHILD" to loosen up the harness, then follow step 2 to unlock the child.

8 REMOVAL

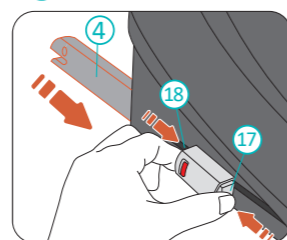

While pressing and holding both ISOFIX Release Button A (17) and ISOFIX Release Button B (18), slide the ISOFIX Connector (4) into the child seat Base. This shall be done on both sides of the child seat.

9 CARE AND MAINTENANCE CARE AND MAINTENANCE

Always check the buckle to ensure it is not blocked and functions properly at all time.

You may want to remove and wash the cover from time to time. Please do so with mild detergent in the delicates programme of the washing machine (30°C). Please refer to the washing label of the cover. The plastic parts and the buckle can be cleaned with a mild soap and water.

⚠ DANGER The child seat must not be used without the AVOVA seat cover. The cover is a safety feature and may only be replaced by an original AVOVA cover.

REMOVING AND REFITTING THE SEAT COVER

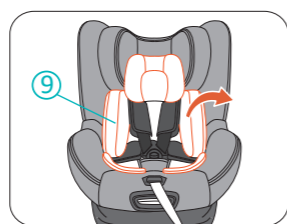

1. Adjust the child seat to forward-facing, child seat Shell at its upright position and Headrest at its highest position.
2. Remove the Newborn Insert (9).

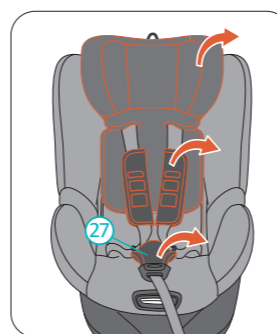

3. Remove the headrest cover.

4. Unbuckle the 5-Point Harness. Remove the Chest Pads and the Crotch Pad (27).

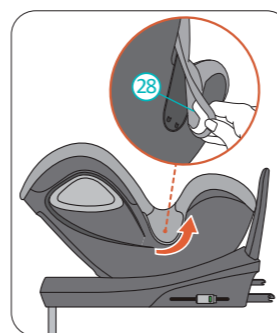

5. Release the cover hooks (28) on both sides. Then remove the child seat shell cover.

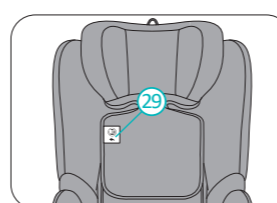

Before washing the fabric cover, please remove the user manual from the storage pocket (the label (29) on the cover indicates the user manual storage position) to avoid damage. Make sure to keep the user manual in a safe place, and return it to the storage pocket after reinstalling the fabric cover.

Please refit the cover in the reverse order.

10 WARRANTY

1. The warranty for AVOVA Alera 1 lasts for 2 years from the date of original purchase from new. The usage of the product should be in accordance with this user manual. Any damage caused by operations against the instructions in this user manual will void the warranty.

2. Please keep your proof of purchase properly in case of a warranty claim.

3. Never use third parties for maintenance, repair or modification otherwise you will void the warranty. Always check with AVOVA retailers for advice.

If you have any further questions regarding the child seat's use, please feel free to contact us:

AVOVA GmbH
Blaubeurer Straße 71
89077 Ulm
Germany

T: +49 731 379941-0
info@avova-childcare.com
www.avova-childcare.com

11 DISPOSAL

When you need to dispose of the child seat, please refer to your local waste disposal regulations. If you have further questions, please contact your communal waste management or administration of your city.